

BER Performance of Alamouti with VBLAST Detection Schemes over MIMO System

Varinder Pal Singh
Research Scholar, Department of ECE,
GIMET College,
Amritsar, India
varinder1992@yahoo.com

Garima Malik
Assistant Professor, Department of ECE,
GIMET College,
Amritsar, India
garimamalik@ymail.com

Abstract— Multiple-Input Multiple-Output (MIMO) systems as a means to combat fading in wireless channels. MIMO allows higher throughput, diversity gain and interference reduction. In this paper, we analyze the Bit Error Rate (BER) performance of the Alamouti Space Time Block Code with V-BLAST (Vertical Bell Laboratories Layered Space-Time) over MIMO system. Basic idea in this scheme is to improve the BER performance of systems. V-BLAST algorithm offers highly better error performance than conventional linear receivers and still has low complexity. The simulated results are based on different modulations, such as BPSK, 4-QAM and 16-QAM over Rayleigh fading channels.

Keywords- BER, Rayleigh fading, MIMO system, ZF, BPSK, QAM, Alamouti Scheme and V-BLAST.

I. INTRODUCTION

The research community has generated a number of promising solutions for significant improvements in system performance. One of the most promising future technologies in mobile radio communications is multi antenna elements at the transmitter and receiver. The multiple-antennas at the transmitter and/or at the receiver in a wireless communication link open a new dimension in reliable communication, which can improve the system performance substantially. The idea behind MIMO is that the transmit antennas at one end and the receive antennas at the other end are “connected and combined” in such a way that the quality (the bit error rate and/or the data rate) for each user is improved [5]. The core idea in MIMO transmission is space-time signal processing in which signal processing in time is complemented by signal processing in the spatial dimension by using multiple, spatially distributed antennas at both link ends [10].

Several transmission schemes have been proposed that utilize the MIMO channel in different ways, e.g., spatial multiplexing, space-time coding or Beamforming. Space-time coding (STC) is the promising method where the number of the transmitted code symbols per time slot are equal to the number of transmit antennas [9][12]. These code symbols are generated by the space-time encoder in such a way that diversity gain, coding gain, as well as high spectral efficiency are achieved. Space-time coding finds its application in cellular communications as well as in wireless local area networks. Some special detection algorithms have been proposed in order to exploit the high spectral capacity offered by MIMO channels. One of them is the V-BLAST (Vertical Bell-Labs Layered Space-Time) algorithm which uses a layered structure [2]. This algorithm offers highly better error performance than conventional linear receivers and still has low complexity. In this paper, we offer a new MIMO technique Alamouti with V-BLAST.

This paper describes a wireless transmission using the concept of MIMO. The paper is organized as follows. In section II discussed Alamouti Scheme using two transmits antennas and one receive antenna. In section III discuss the nonlinear decoding technique V-BLAST. In section IV

simulation results are presented and discussed. Finally, section V concludes the paper.

II. ALAMOUTI SCHEME

A particularly elegant scheme for MIMO coding was developed by Alamouti. The associated codes are often called MIMO Alamouti codes or just Alamouti codes. The MIMO Alamouti scheme is an ingenious transmit diversity scheme for two transmit antennas that does not require transmit channel knowledge [4]. There are three receive diversity schemes Selection combining, Equal Gain Combining and Maximal Ratio Combining. All the three approaches used the antenna array at the receiver to improve the demodulation performance, albeit with different levels of complexity. Time to move on to a transmit diversity scheme where the information is spread across multiple antennas at the transmitter [13].

The block diagram of the Alamouti space-time encoder is shown in Figure 1

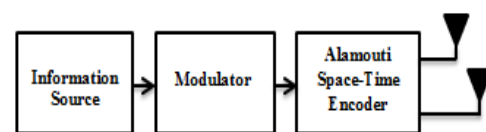

Fig. 1 Block Diagram of MIMO Alamouti scheme

The information bits are first modulated using an M-array modulation scheme. The encoder takes the block of two modulated symbols x_1 and x_2 in each encoding operation and hands it to the transmit antennas according to the code matrix

$$X = \begin{bmatrix} x_1 & -x_2^* \\ x_2 & x_1^* \end{bmatrix} \quad (1)$$

The first column represents the first transmission period and the second column the second transmission period. During the first transmission, the symbols x_1 and x_2 are transmitted simultaneously from antenna one and antenna two respectively. In the second transmission period, the symbol $-x_2^*$ is transmitted from antenna one and the x_1^* symbol from transmit antenna two. Now we take the case of Alamouti

scheme using two transmitter antennas and one receiver antenna the scheme provides the same diversity order as maximal-ratio receiver combining with one transmitter antenna, and two receiver antennas.[13][14] Receiver with Alamouti STBC:

In the first time slot, the received signal is,

$$y_1 = h_1 x_1 + h_2 x_2 + n_1 = [h_1 \quad h_2] \begin{bmatrix} x_1 \\ x_2 \end{bmatrix} + n_1 \quad (2)$$

In the second time slot, the received signal is,

$$y_2 = -h_1 x_2^* + h_2 x_1^* + n_2 = [h_1 \quad h_2] \begin{bmatrix} -x_2^* \\ x_1^* \end{bmatrix} + n_2 \quad (3)$$

Where, y_1, y_2 are represented the received symbol, h_1 and h_2 are represented the channels from 1st and 2nd transmit antenna to receive antenna, x_1, x_2 are the transmitted symbols and n_1, n_2 is the noise on 1st, 2nd time slots. Then the two noise terms are independent and identically distributed,

$$E \left\{ \begin{bmatrix} n_1 \\ n_2 \end{bmatrix} \begin{bmatrix} n_1^* & n_2^* \end{bmatrix} \right\} = \begin{bmatrix} |n_1|^2 & 0 \\ 0 & |n_2|^2 \end{bmatrix} \quad (4)$$

The (5) equation can be represented in matrix notation as follows:

$$\begin{bmatrix} y_1 \\ y_2 \end{bmatrix} = \begin{bmatrix} h_1 & h_2 \\ h_2^* & -h_1^* \end{bmatrix} \begin{bmatrix} x_1 \\ x_2 \end{bmatrix} + \begin{bmatrix} n_1 \\ n_2 \end{bmatrix} \quad (5)$$

Let us define $H = \begin{bmatrix} h_1 & h_2 \\ h_2^* & -h_1^* \end{bmatrix}$. To solve for $\begin{bmatrix} x_1 \\ x_2 \end{bmatrix}$, we know that we need to find the inverse of H . We know, for a general m x n matrix, the pseudo inverse is defined as,

$$H^+ = (H^H H)^{-1} H^H \quad (6)$$

$$(H^H H) = \begin{bmatrix} h_1^* & h_2 \\ h_2^* & -h_1^* \end{bmatrix} \begin{bmatrix} h_1 & h_2 \\ h_2^* & -h_1^* \end{bmatrix} = \begin{bmatrix} |h_1|^2 + |h_2|^2 & 0 \\ 0 & |h_1|^2 + |h_2|^2 \end{bmatrix} \quad (7)$$

The estimate of the transmitted symbol is,

$$\begin{bmatrix} x_1 \\ x_2 \end{bmatrix} = (H^H H)^{-1} H^H \begin{bmatrix} y_1 \\ y_2 \end{bmatrix} \quad (8)$$

III. RECEIVER DESIGN USING V-BLAST

Some special detection algorithms have been proposed in order to exploit the high spectral capacity offered by MIMO channels. One of them is the V-BLAST (Vertical Bell-Labs Layered Space-Time) algorithm which uses a layered structure

[15][17]. This algorithm offers highly better error performance than conventional linear receivers and still has low complexity. V-Blast is a single user scheme which has multiple transmitters. It divides the data stream into substreams and transmits them through multiple transmitters at the same time and frequency. This results in receiving the data at the receiver at the same time and frequency. By implementing VBLAST algorithm, the diversity gain is increased and the bit error rate (BER) performance is improved. The MIMO system is assumed to undergo flat fading channel.

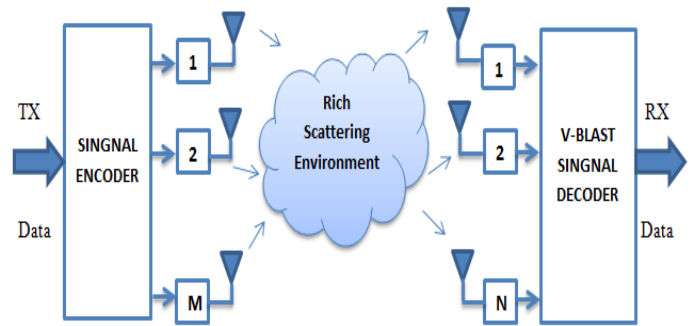

Fig. 2 Block diagram of VBLAST

Steps for V-BLAST detection:

- Ordering: choosing the best channel
- Nulling: using Zero Forcing (ZF) decoding algorithm
- Slicing: making a symbol decision
- Canceling: subtracting the detected symbol
- Iteration: going to the first step to detect the next symbol

At the transmitter, each antenna sends its own independently coded symbol, while at the receiver a spatial domain generalized decision feedback equalizer is employed. The symbols are decoded on an individual basis, starting from the symbol with the minimum estimation error. Once this symbol is decoded, its interference with the other symbols is removed by appropriately subtracting it from the received signal. The decoder then proceeds to decode the remaining symbols in a similar fashion [15]. This process of successive interference cancellation can however cause performance degradation because of potential decoding error propagation. In specific, the contribution of this paper, we consider the case of a flat fading channel and derive an efficient procedure to design a Alamouti and decoder for the VBLAST/ZF system [16].

IV. SIMULATIONS AND RESULTS

A. Simulation

In this simulation, the transmitter consists of a binary random generator, Digital modulator and a Alamouti 2x1(Two transmitter and one receiver) encoder. The binary random generator generates the transmitted bits. These bits are modulated in the modulator. The Alamouti encoder maps the symbols to each antenna. In the channel block, the transmitted symbols undergo Rayleigh flat fading. The receiver is made up of V-BLAST decoding processing and an error rate calculation block. Simulation based on Alamouti 2x1 with nonlinear

technique V-BLAST/Zero Forcing over Rayleigh flat fading channel.

Finally the SER is calculated by comparing the originally transmitted symbols with received symbols that are estimated at the receiver. The Simulation block diagram for Alamouti with V-BLAST scheme is given below.

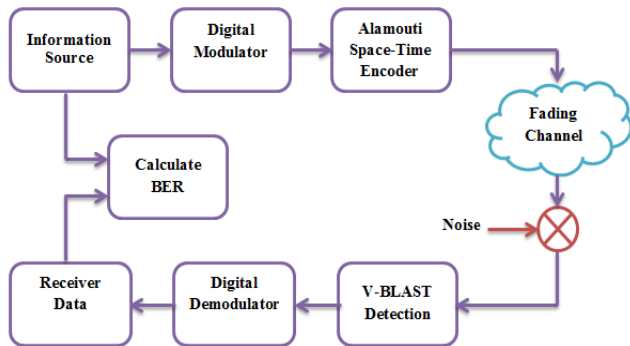

Fig. 3 Simulation block diagram for Alamouti with V-BLAST scheme

The performance of Alamouti codes depends on the type of modulation and the number of transmit and receive antennas used. This scheme with larger number of transmit antennas always give better performance than space-time block codes with lower number of transmit antennas. This is true because larger number of transmit antennas means larger transmission matrices which means transmitting more data.

B. Results

Different modulation technique has been employed on MIMO system for evaluating the bit error rate performance of Alamouti scheme with V-BLAST/ZF. Simulator software is MATLAB.

The parameters are shown in table below:

| S.No. | Parameter | Value |
|-------|-----------------------|---------------------|
| 1. | Technology | MIMO |
| 2. | Data rate | 1×10^3 |
| 3. | Encoding Algorithm | Alamouti STBC |
| 4. | Number of Transmitter | 2 |
| 5. | Number of Receiver | 1 |
| 6. | Decoding Algorithms | V-BLAST/ZF |
| 7. | Modulation Technique | BPSK, 4-QAM, 16-QAM |
| 8. | Channel | Flat Rayleigh |
| 9. | SNR | 26 |

Table.1: Simulation parameters

Case 1: Here the MIMO system is considered for two transmitting antennas and one receive antenna for Alamouti scheme with VBLAST/ZF in Rayleigh fading channel. In this case modulation technique is BPSK. Graph of Bit Error Rate is shown in figure 4.

Case 2: Here the MIMO system is considered for two transmitting antennas and one receive antenna for Alamouti scheme with VBLAST/ZF in Rayleigh fading channel. In this case modulation technique is 4-QAM. Graph of Bit Error Rate is shown in figure 5.

Case 3: Here the MIMO system is considered for two transmitting antennas and one receive antenna for Alamouti scheme with VBLAST/ZF in Rayleigh fading channel. In this case modulation technique is 16-QAM. Graph of Bit Error Rate is shown in figure 6.

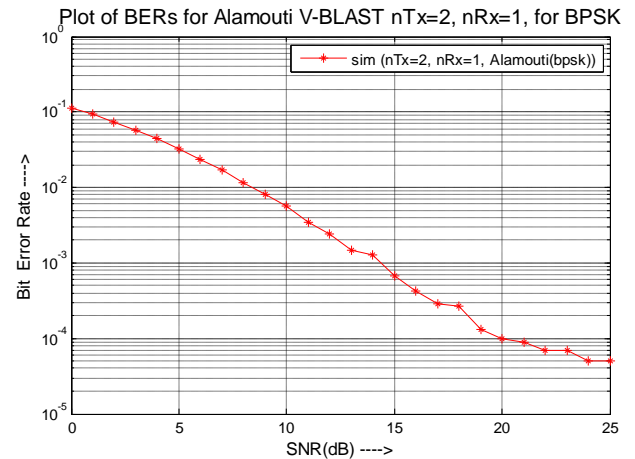

Fig. 4 Bit Error Rate of Alamouti V-BLAST for BPSK

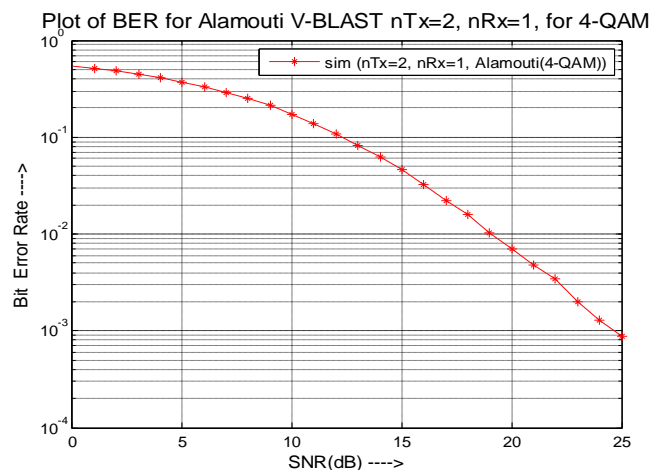

Fig. 5 Bit Error Rate of Alamouti V-BLAST for 4-QAM

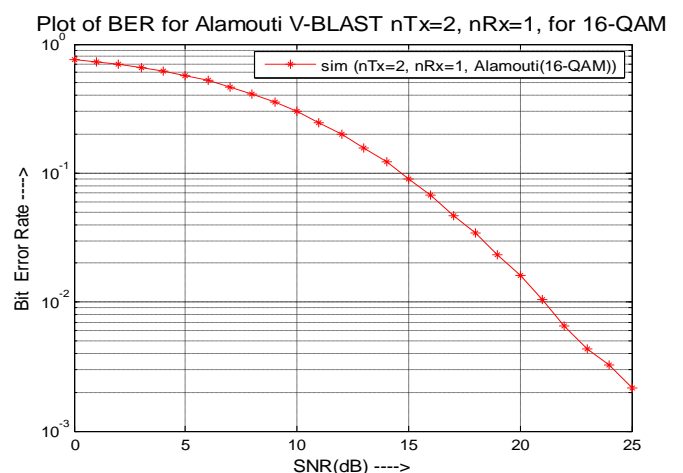

Fig. 6 Bit Error Rate of Alamouti V-BLAST for 16-QAM

Now compare the performance of BPSK, 4 QAM, and 16 QAM for Alamouti scheme with VBLAST/ZF. From the figures (7), it is very clear to see the performance of Alamouti scheme with VBLAST/ZF using 16-QAM, 4QAM, and BPSK modulation schemes. The performance of bit-error-rate using BPSK modulation is better than the performance of space-time block codes using 4QAM and 16-QAM modulations. The performance of Alamouti scheme using 4-QAM modulation is better than the performance of Alamouti scheme using 16-QAM modulation. This better performance is due to the number of bits that each modulated symbol can take. All BPSK modulated symbols can take only one bit at a time. However, 4-QAM modulated symbols take two bits and 16-QAM takes four bits per modulated symbol.

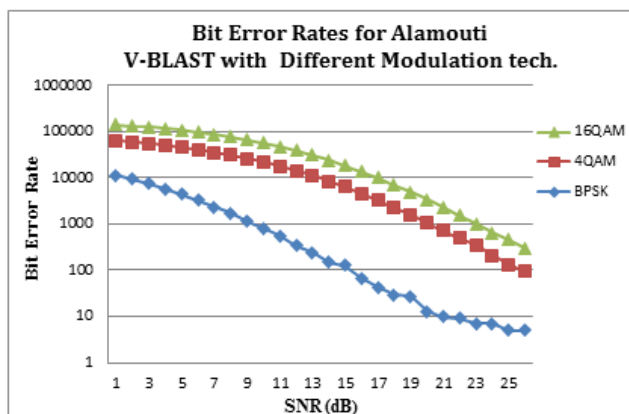

Fig. 7 Bit Error Rate of Alamouti V-BLAST with different Modulation technique

V. CONCLUSION

We have presented an Alamouti scheme (Two transmitter antennas and one receive antenna) based MIMO system and a receiver algorithm with very low complexity. This scheme has the advantage of achieving a high spatial diversity order in the absence of channel knowledge at the transmitter while keeping the number of receive antennas at the mobile set to a small number. In this paper, analyzed the BER performance of Alamouti scheme with V-BLAST over Rayleigh fading channels, which achieves spatial multiplexing and diversity gains simultaneously and also compared BER performance of BPSK, 4QAM, 16QAM. Based on the simulation results we conclude that the BER performance of Alamouti scheme with V-BLAST using BPSK modulation is better than the using 4QAM and

ACKNOWLEDGMENT

I would like to thank my guide for their suggestion and helpful feedback to my work.

REFERENCES

- [1] E. Telatar. Capacity of multi-antenna Gaussian channels. Technical report, AT & T Bell Labs, June 1995.
- [2] L. Zheng and D. Tse. Diversity and Multiplexing: A Fundamental Tradeoff in Multiple-Antenna Channels. *IEEE Trans. on Inform. Theory*, 49(5):1073–1096, May 2003.
- [3] T. Bonald, S. Borst, N. Hegde, and A. Prouti ` ere. Wireless data performance in multi-cell scenarios. In *ACM Sigmetrics*, June 2004

- [4] S. Alamouti, —Space block coding: A simple transmitter diversity technique for wireless communications, *IEEE J. Select. Areas. Commun.*, vol. 16, pp. 1451–1458, Oct. 1998.
- [5] Dorra Ben Cheikh Battikh, N. Seshadri, and A. R. Calderbank, “Dynamic System Performance of SISO, MISO and MIMO Alamouti Schemes,” *IEEE Trans. Inf. Theory*, vol. 44, no. 2, pp. 744–765, Mar.2013.
- [6] J. Liu, J.-K. Zhang, and K. M. Wong, “On the designs of minimum BER linear space-time block codes for MIMO systems equipped with MMSE receivers,” *IEEE Trans. Signal. Process.*, vol. 54, no. 8, pp. 3147–3158, Aug. 2006.
- [7] Xu Shun, J.-K. Zhang, and K. M. Wong, “Performance research of MIMO system based on Alamouti Space time coding,” *IEEE Trans. Inf. Theory*, vol. 54, no. 10, pp. 4511–4527, Oct. 2012.
- [8] Shikha Gupta and X.-G. Xia, “Performance Analysis of Alamouti and Orthogonal Space Time Block Codes In MIMO System under Rayleigh Fading Scenario,” *IEEE Trans. Inf. Theory*, vol. 54, no. 10, pp. 4528–4547, Oct. 2014.
- [9] X. Guo and X.-G. Xia, “On full diversity space-time block codes with partial interference cancellation group decoding,” *IEEE Trans. Inf. Theory*, vol. 55, no. 10, pp. 4366–4385, Oct. 2009.
- [10] Shubhangi Chaudhary, P.Stoica and E.G.Larsson,“ Performance analysis of MIMO-space time block coding with Different modulation techniques“, *WPC*, Vol.28, pp.287-312, March 2012.
- [11] Shubhangi Chaudhary, N. Seshadri, and A. R. Calderbank, “Comparison of Wireless MIMO System Under Alamouti’s Scheme and Maximum Ratio Combining Technique,” in *Proc. 2013 Asilomar Conf. Signals, Systems and Computers*, pp. 1803–1810.
- [12] S. Sirianunpiboon, A. R. Calderbank, and S. D. Howard, “Bayesian analysis of interference cancellation for Alamouti multiplexing,” *IEEE Trans. Inf. Theory*, vol. 54, no. 10, pp. 4755–4761, Oct. 2008.
- [13] Alamouti STBC by KRISHNA SANKAR on *OCTOBER 16, 2008*.
- [14] A Simple Transmit Diversity Technique for Wireless Communication Siavash M Alamouti, *IEEE Journal on selected areas in Communication*, Vol 16, No, 8, October 1998
- [15] P. W. Wolniansky, G. J. Foschini, G. D. Golden and R. A. Valenzuela “V-BLAST: An Architecture for Realizing Very High Data Rates Over the Rich-Scattering Wireless Channel”. *Bell Laboratories*.
- [16] Taekyu Kim and Sin-Chong Park. “Reduced Complexity Detection for V-BLAST D Systems from Iteration Canceling”. 2008.
- [17] Toshiaki. K. “ Low-Complexity Systolic V-BLAST Architecture” *IEEE Transactions on Wireless Communications*, 2009.